







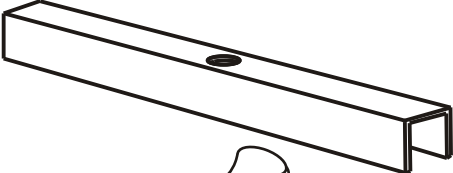
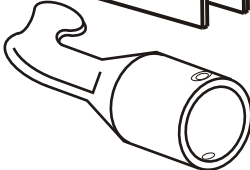

	A (8x)	Sechskantmutter M 8
	C (4x)	Gewindestange M 8x320 mm
	N (2X)	Aufzugsfeder D26,5 d 3,8 x 255 mm
	D (4x)	Überlager U-Profil 20x20x2x200 mm
	E (1x)	Zugstockhaken Ø 30 x 87 mm
	F (2x)	Spanplattenschraube 3 x 16 mm
	G (2x)	Beilagscheibe M 8 x 0,5 mm
	H (2x)	Sicherungsmutter M 8
	I (2x)	Sechskantschraube M 8x16 mm
	K (2x)	Ösenschraube M 5 x 22 mm
	L (2x)	Mutter M 5
	M (2x)	Beilagscheibe M 5 Ø 20 mm
	U (2x)	Kette

1



2

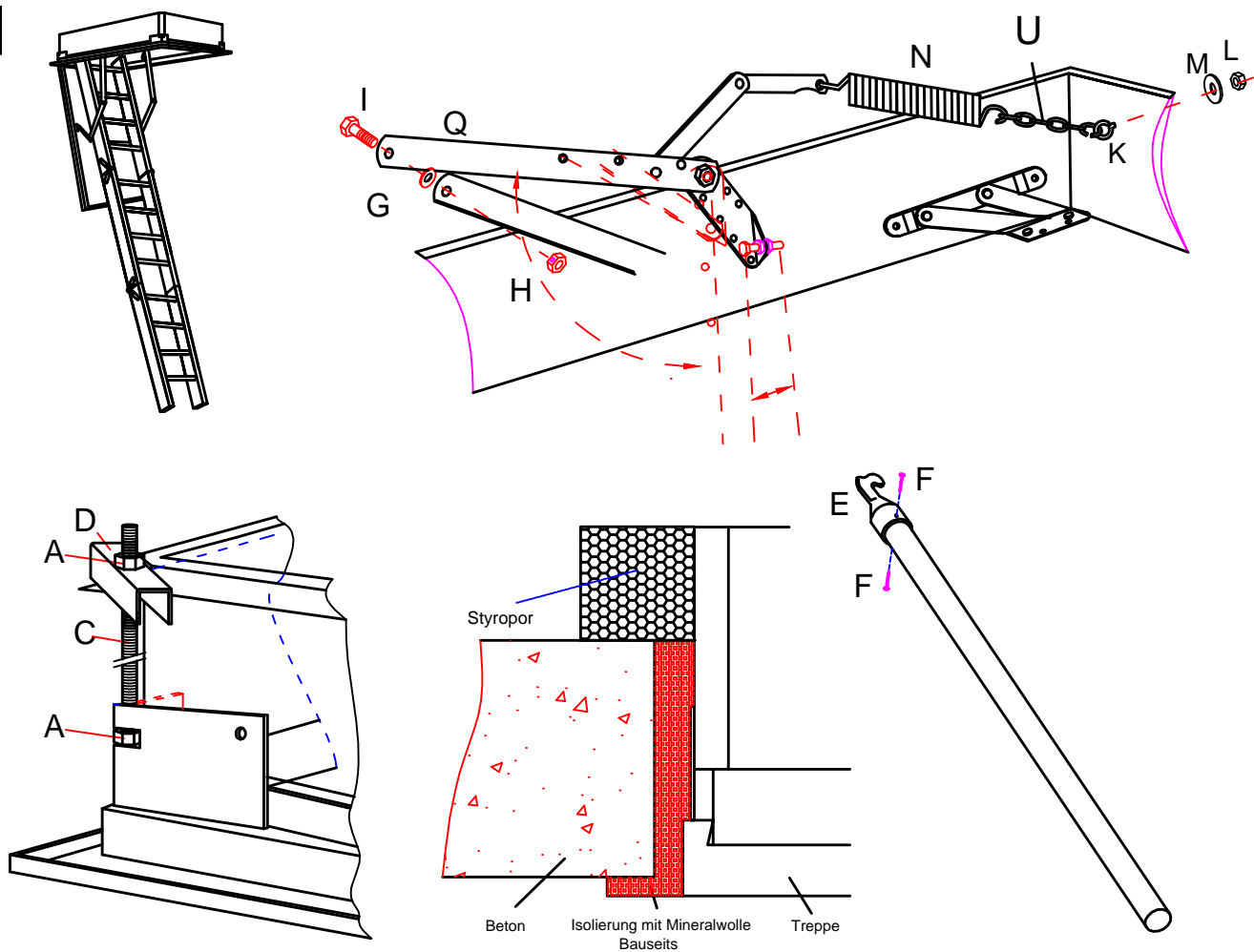