

10	11	12	13	14
1850	2035	2220	2405	2590
-	-	-	-	-
2060	2266	2472	2678	2884

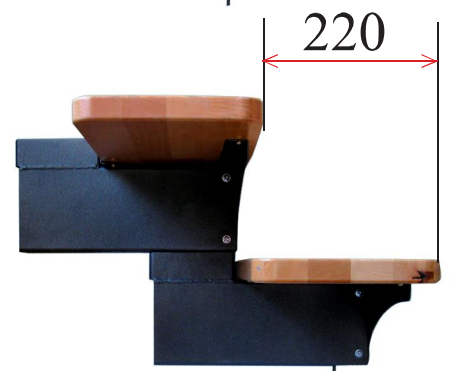

i1		1 x - 933289	i14		26 x - 930738 / 931530 ?? M16 x DIN
i2		12 x - 933290	i15		56 x - 933302 M6 x 12 mm DIN
i3		1 x - 933291	i16		84 x - 930210 5 x 30 mm DIN
i4		14 x - 933292	i17		10 x - 933297 800 x 240 x 35 mm
i5		10 x - 933293	i18		1 x - 933298 40 x 40 x 2 x 800 mm
i6		26 x - 933294	i19		1 x - 933299 35 x 35 x 2 x 700 mm
i7		91 x - 933295 140 x 80 x 3 mm	i20		1 x - 933300 35 x 35 x 2 x 20 mm
i8		9 x - 933296	i21		2 x - 933277 30 x 30 x 20 mm
i9		8 x - 931733 M8 x 55 mm	i22		1 x - 931733 M10 x 35 mm
i10		4 x - 933301 M8 x 90 mm	i23		2 x - 931884 90 x 90 x 80 x 1,5 mm
i11		4 x - 931735 M8 x 70 mm	i24		10 x - 932152 ø 6 x 50 mm
i12		13 x - 931733 M16 x 170 mm	i25		10 x - 932153 ø 6 x 30 mm
i13		26 x - 930737 M16 x DIN	i26		10 x - 930303 ø 8 mm

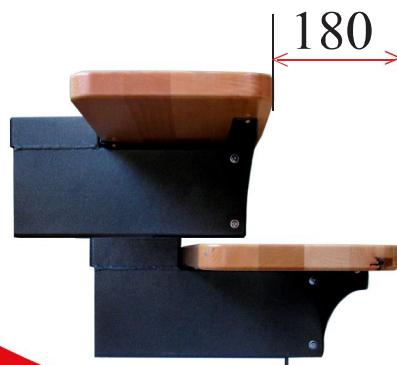
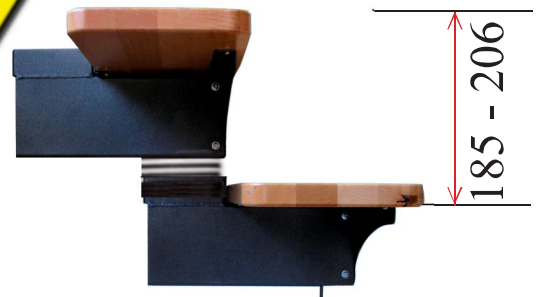
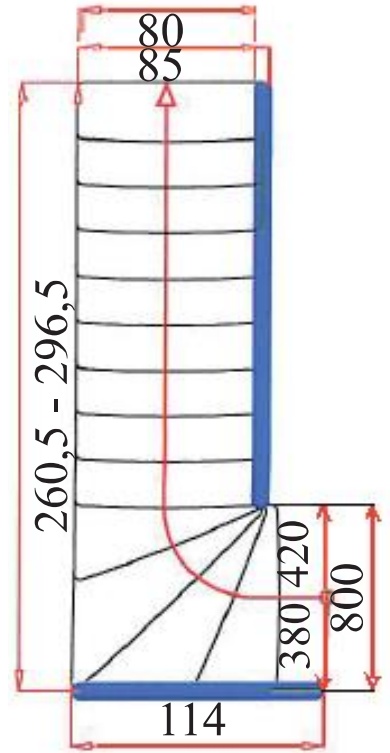

i27		2 x - 930538 M10 x DIN	i43		11 x - 931217
i28		1 x - 930882 M10 x 100 mm	i44		11 x - 932139 ø 5 x 20 mm
i29		1 x - 930687 ø 12 mm	i45		11 x - 930231 M5 - DIN 934
i30	 BUCHE	4 x - 930219 ø 40 x 1055 mm	i46		22 x - 933229 ø 3,5 x 25 mm
i31	 BUCHE	2 x - 933231 ø 40 mm	i47		1 x - 933305 ø 22 x 1430 mm
i32		4 x - 933230 15 x 40 mm	i48		10 x - 933237 ø 6 x 1 x 1500 mm
i33		1 x - 933303	i49		10 x - 933263 ø 8 x 12 mm
i34		10 x - 933304 ø 22 x 1100 mm	i50		5 x - 930219 ø 4 x 40 mm
i35		25 x - 933262	i51		4 x - 933306
i36		29 x - 932141 M6 x 6 mm - DIN 914	i52		4 x - 933307
i37		27 x - 932142 M6 - DIN 562	i53		2 x - 933308 ø 22 x 1 x 225 mm
i38		81 x - 930116 ø 5 x 35 mm	i54	 BUCHE	2 x - 933309
i39		14 x - 930631 ø 22 mm	i55	 BUCHE	2 x - 933310
i40		70 x - 933228	i56		16 x - 930233 M8 x DIN
i41		70 x - 933236 M6 x 14 mm	i57		16 x - 930040 ø 16 mm M8 x DIN 125A
i42		11 x - 932031			



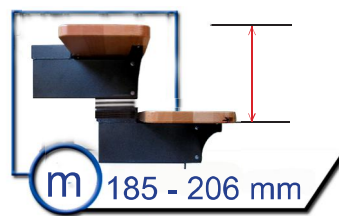
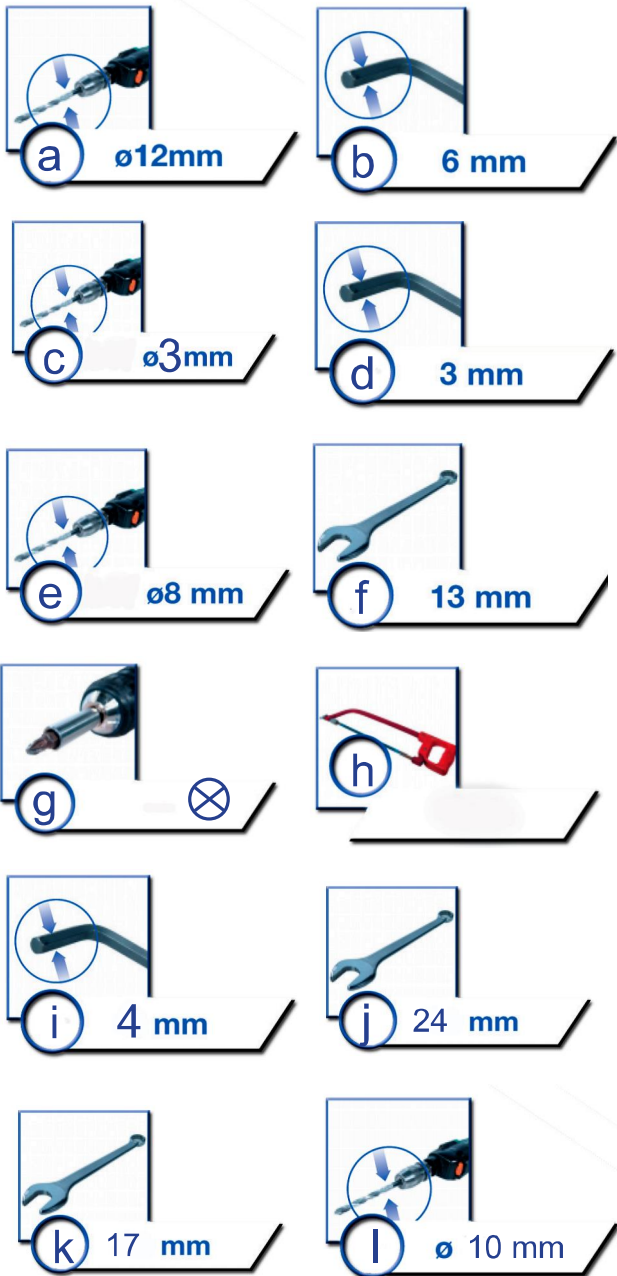

- 0 x i 47 = 185 mm
- 1 x i 47 = 188 mm
- 2 x i 47 = 191 mm
- 3 x i 47 = 194 mm
- 4 x i 47 = 197 mm
- 5 x i 47 = 200 mm
- 6 x i 47 = 203 mm
- 7 x i 47 = 206 mm

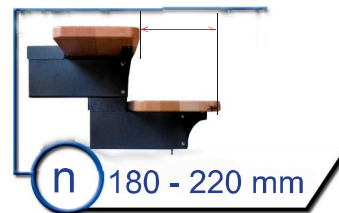

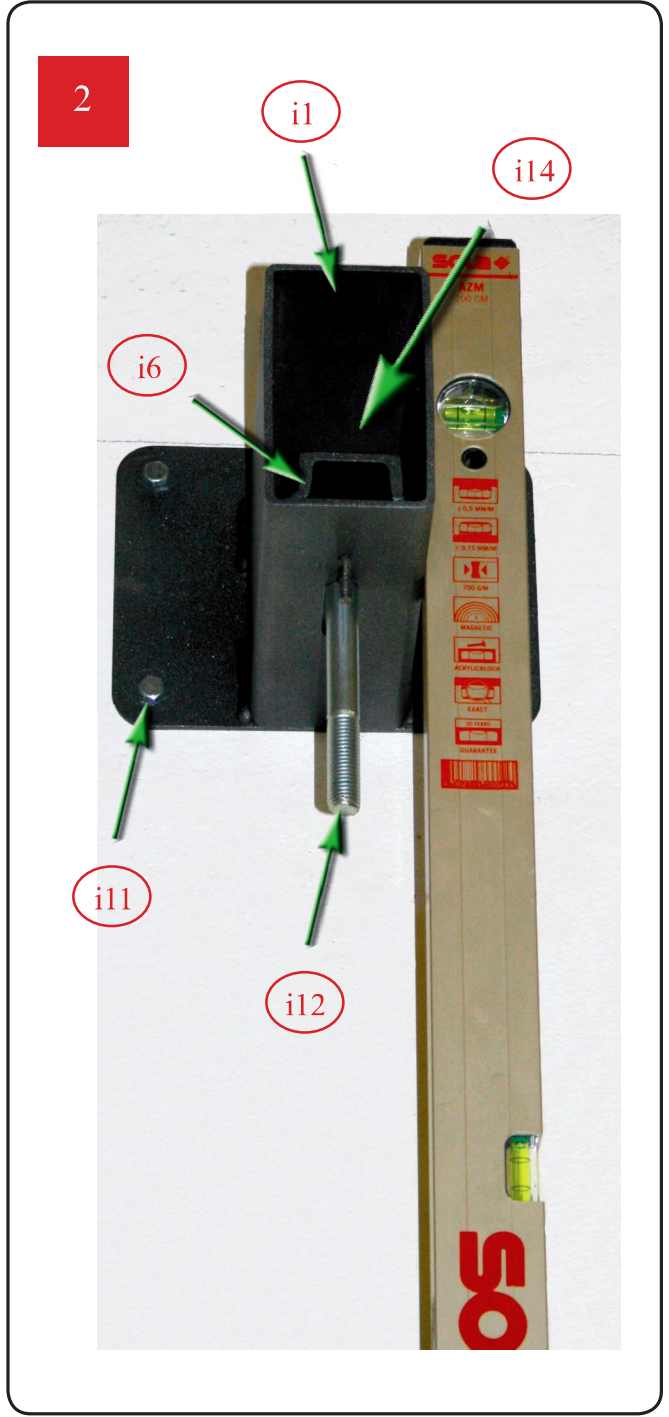
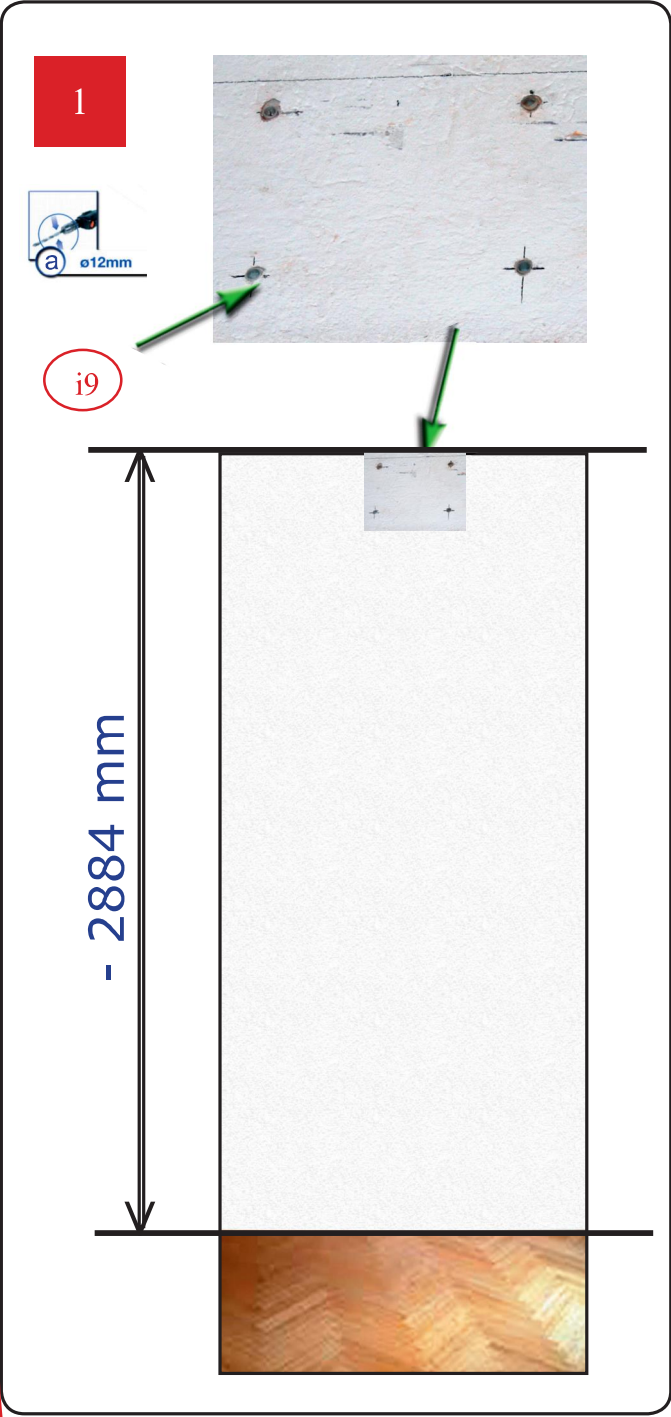

3

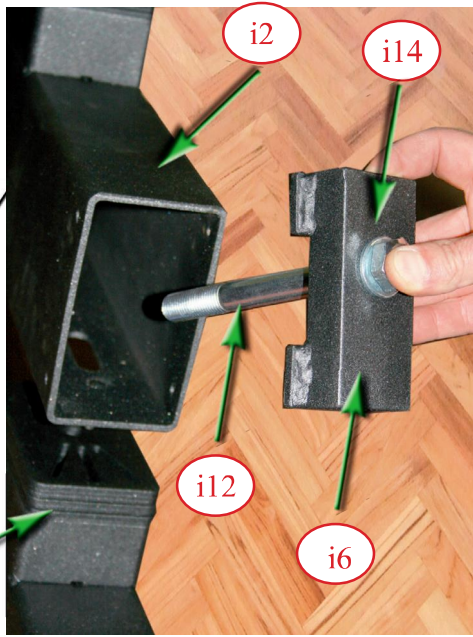
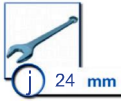

5

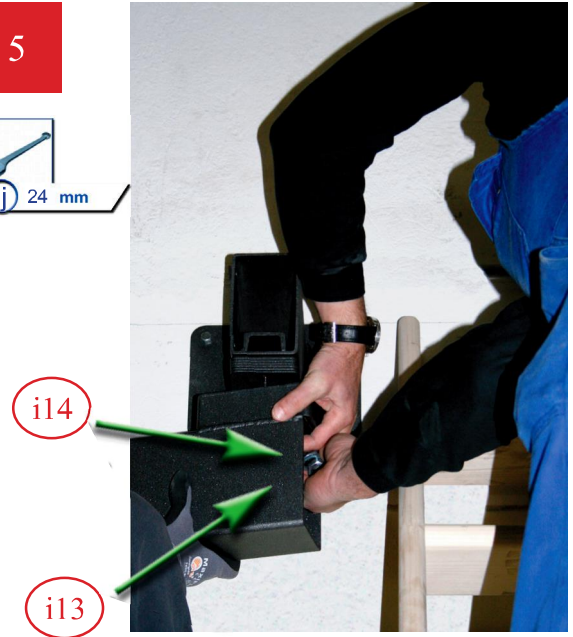

4

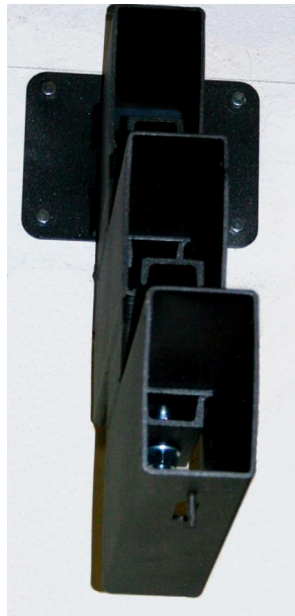

6

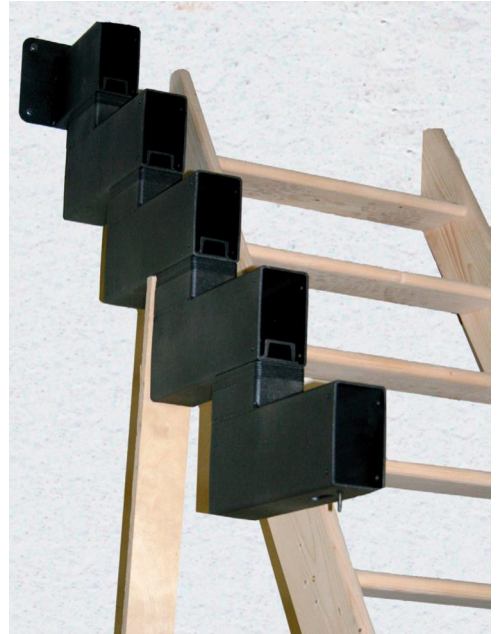

7

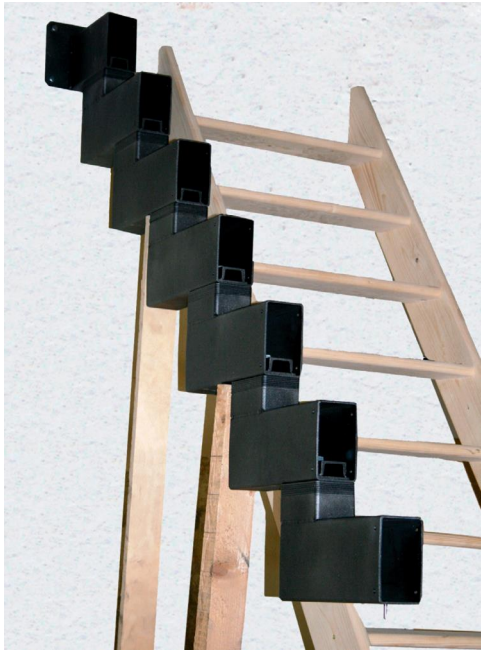

8

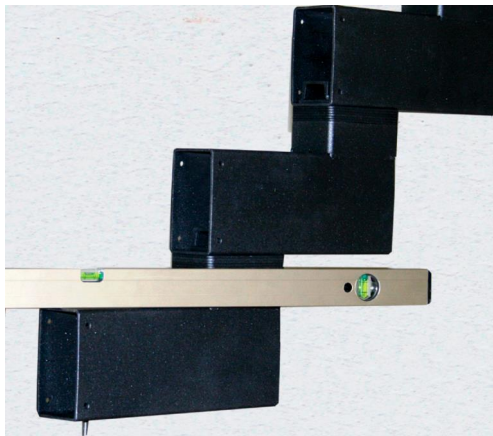

9

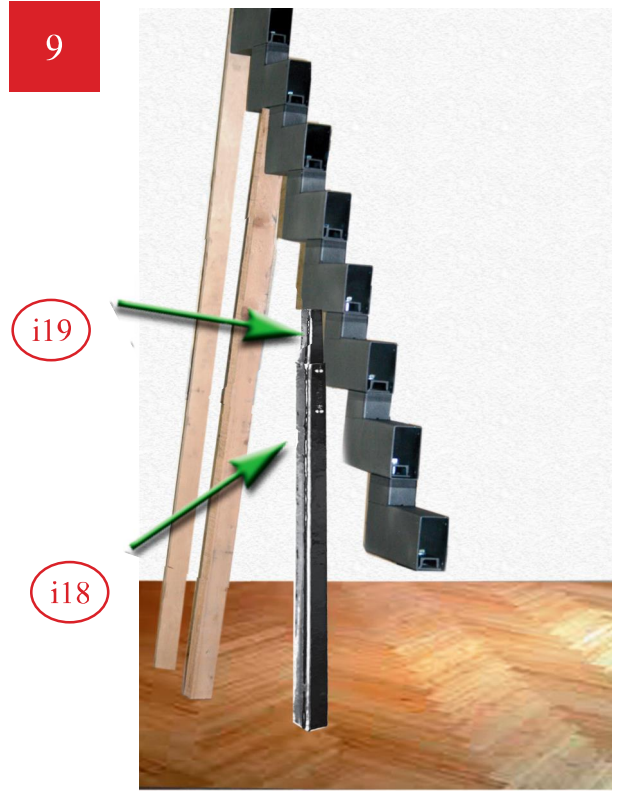

10



11



i29

12



13

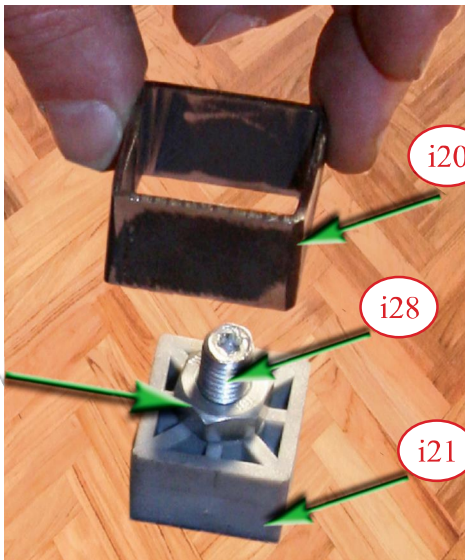

i20

i28

i27

i21

14

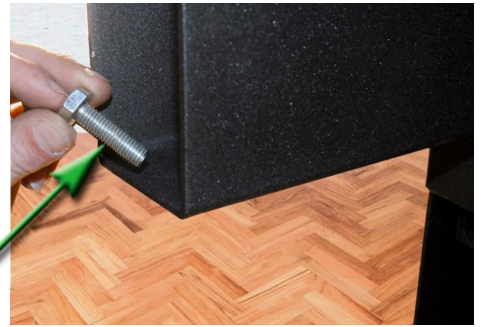

i22

15

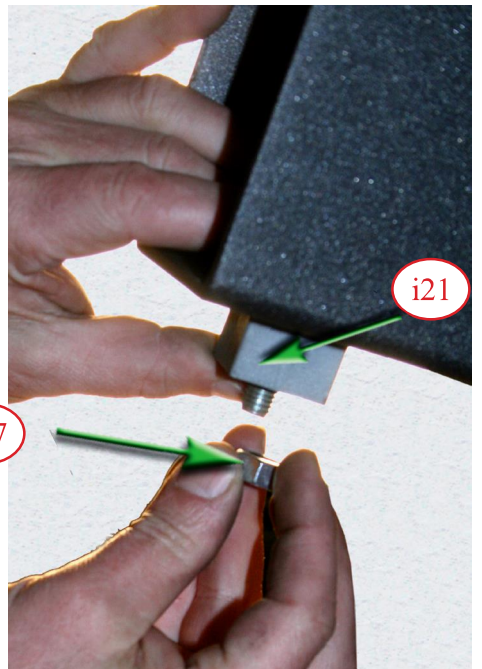

i21

i27



16

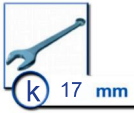

18



17

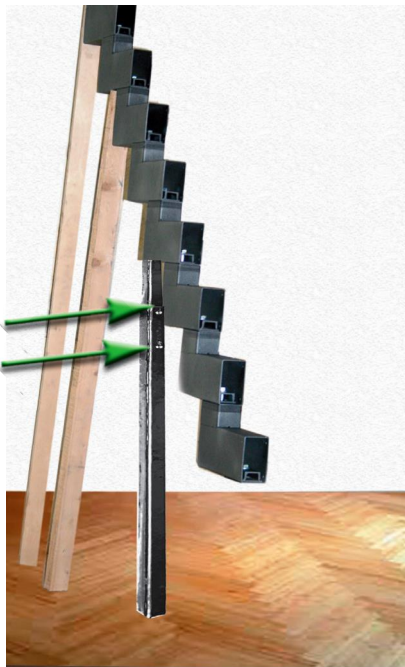
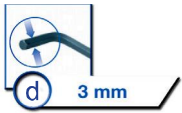

19

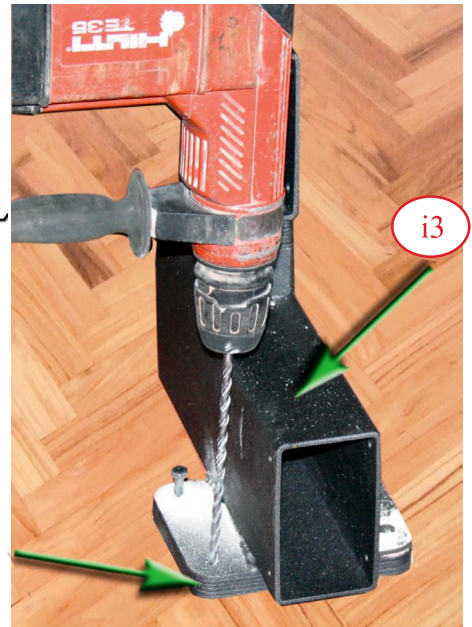

20

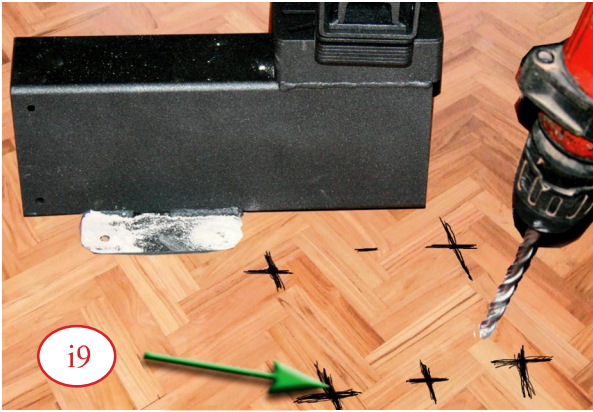

22

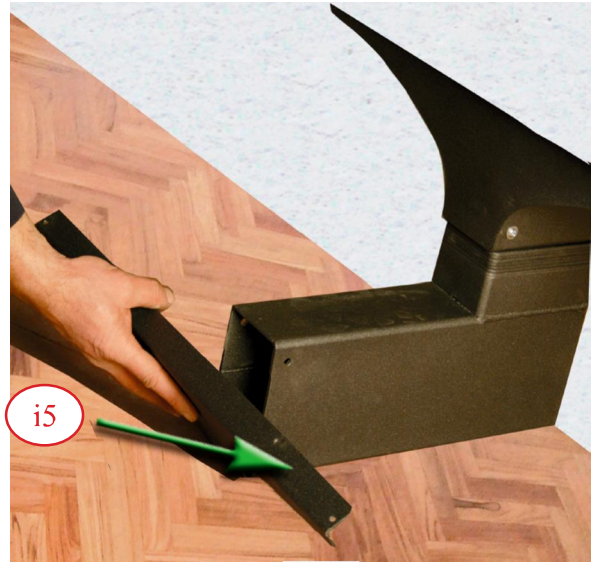

21

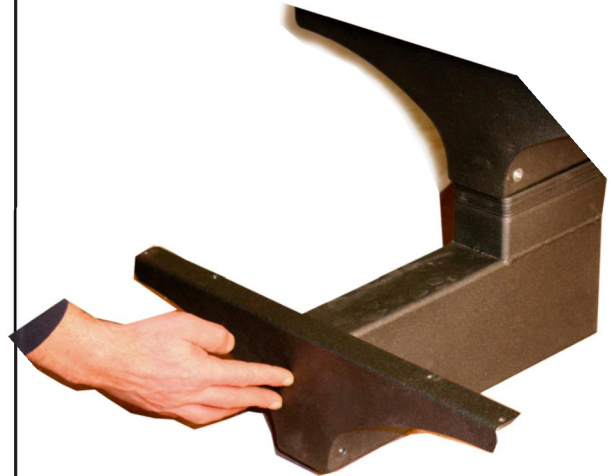
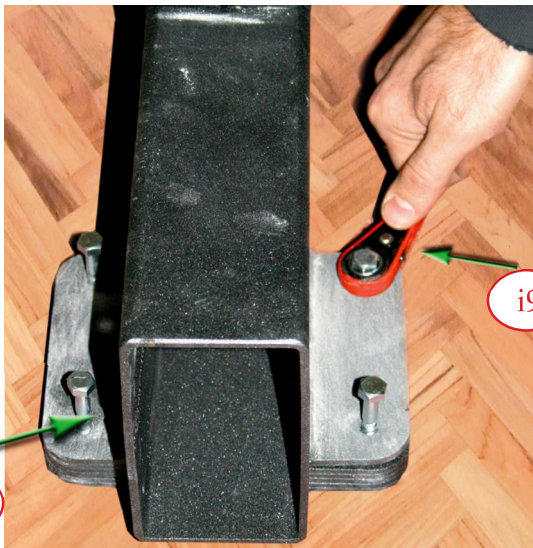
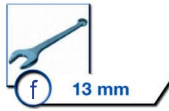

23

i56

i57

i52

i51

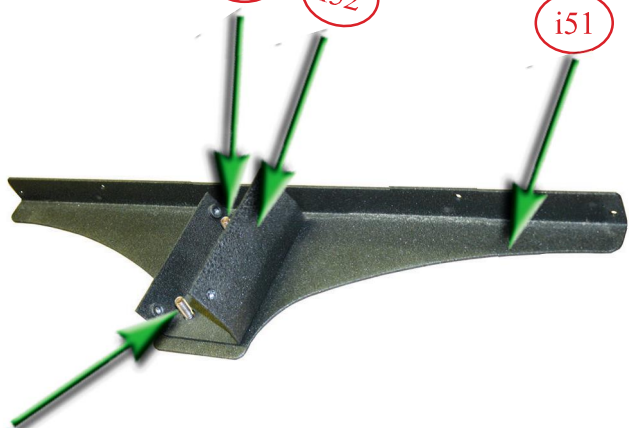

i56 i57



24

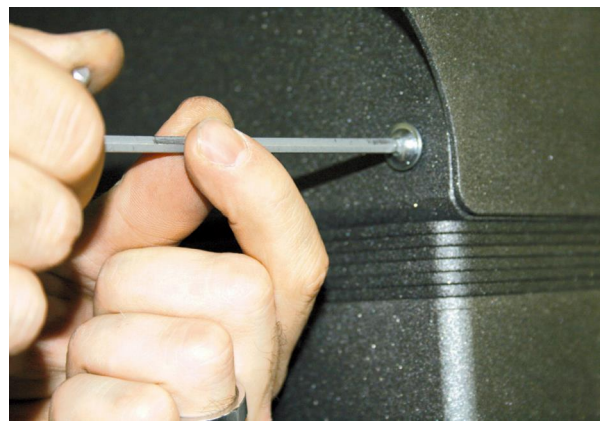

25

i15

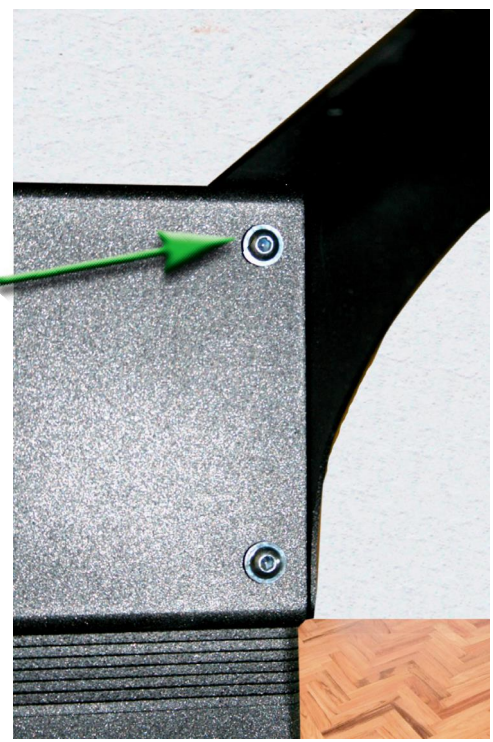

26

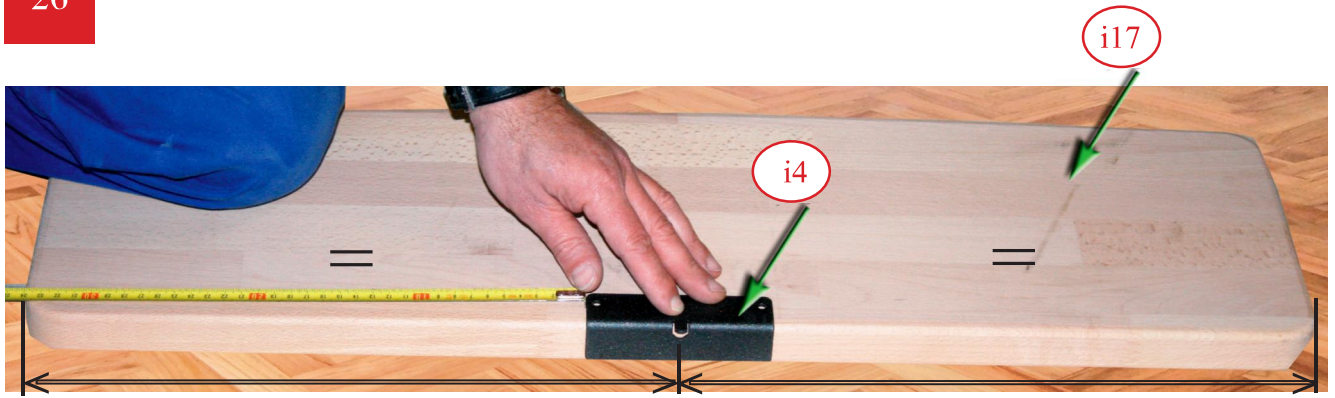

27



28



i16



29

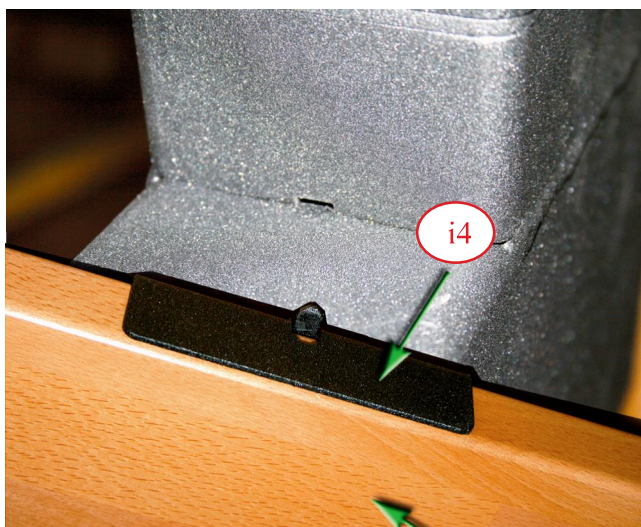

30



31



32



33

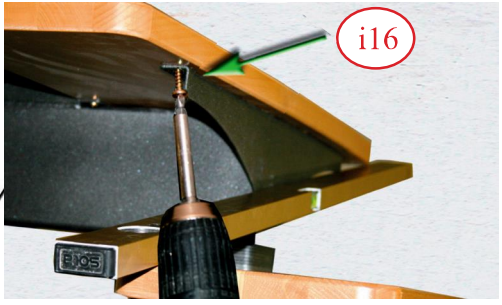

34

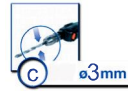

35

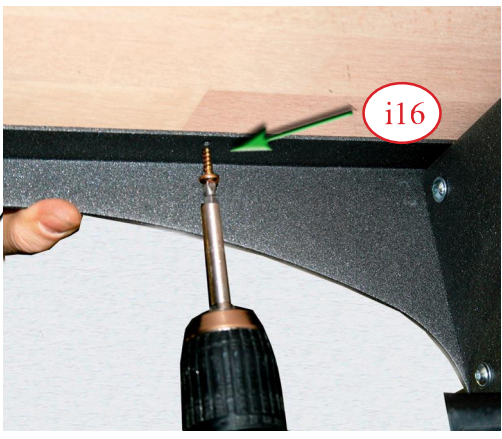

36

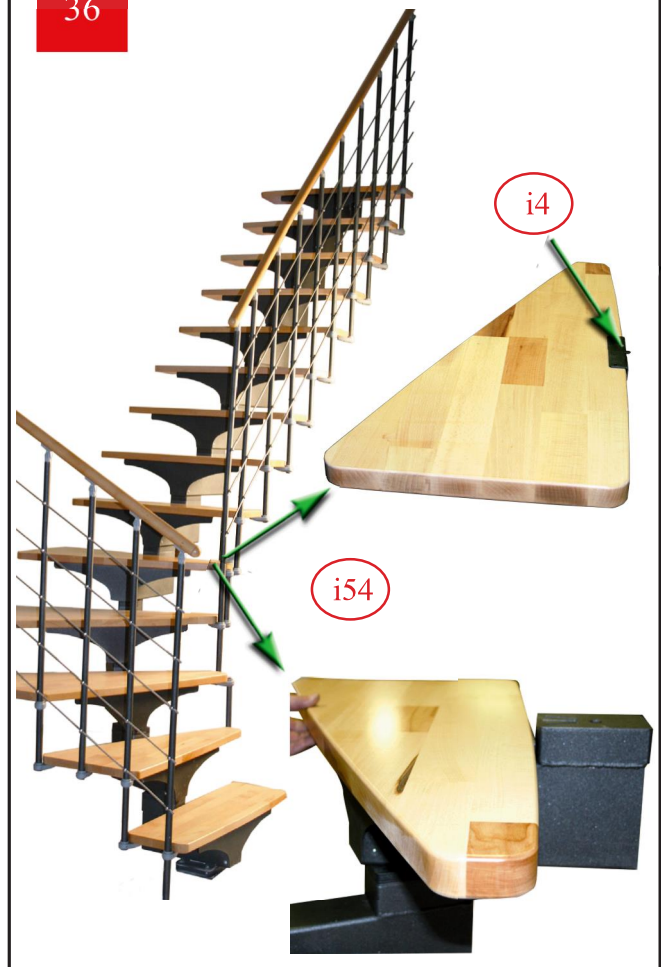

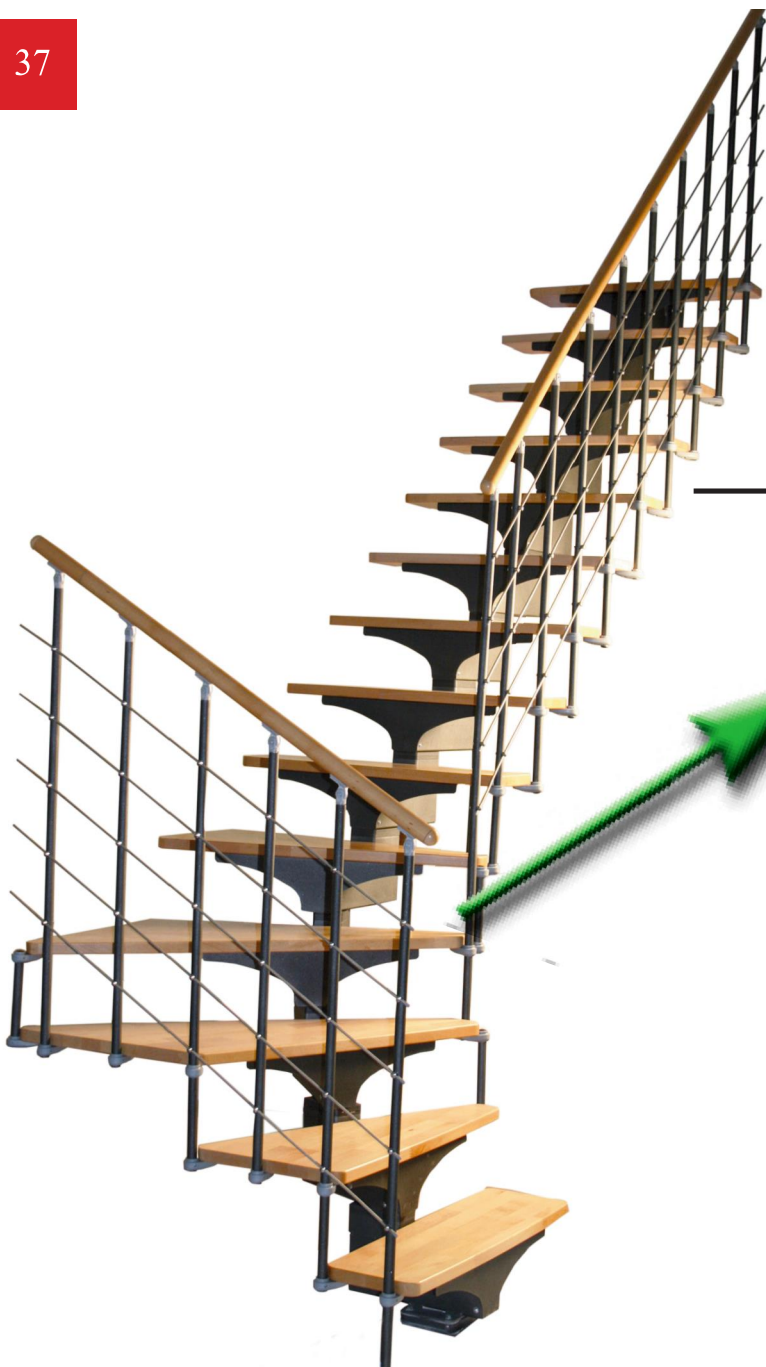

i55





39



40

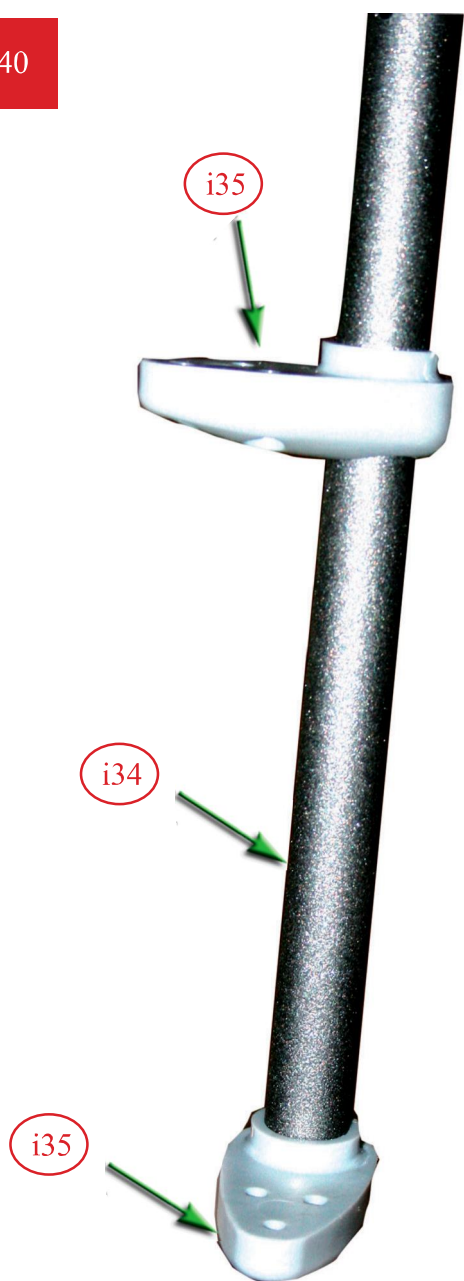

41



42

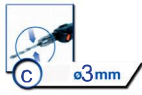

43



44

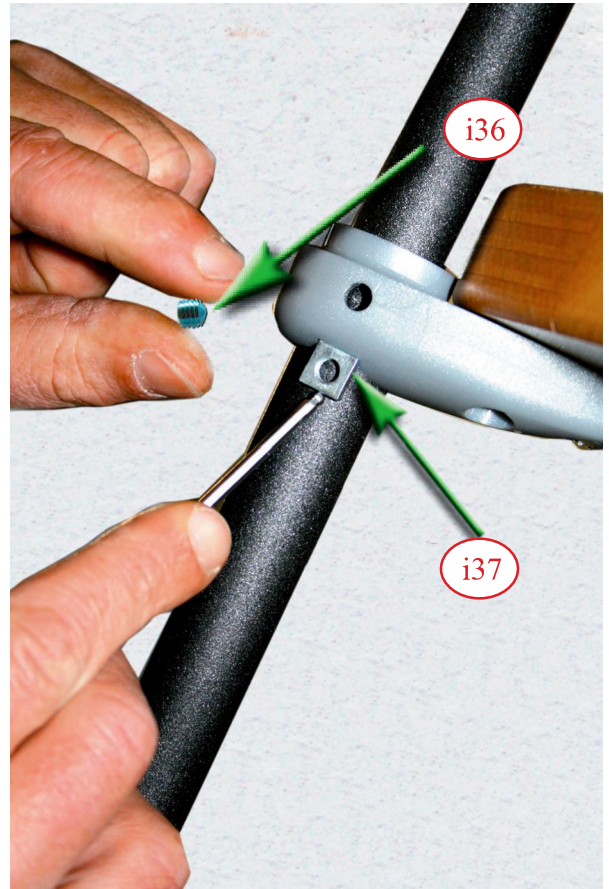
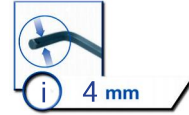

45

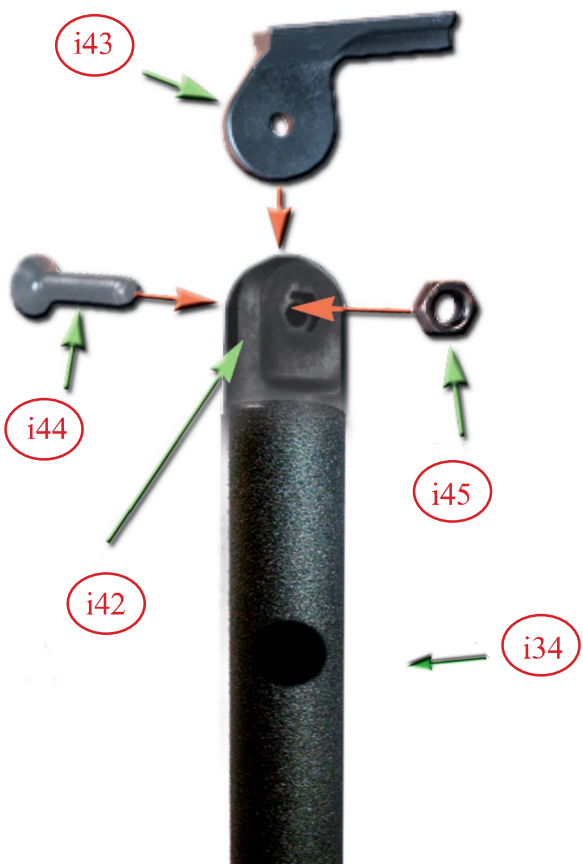
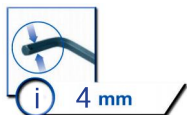

46

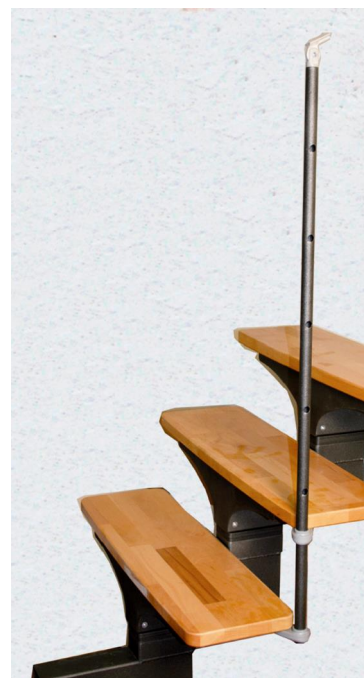

47

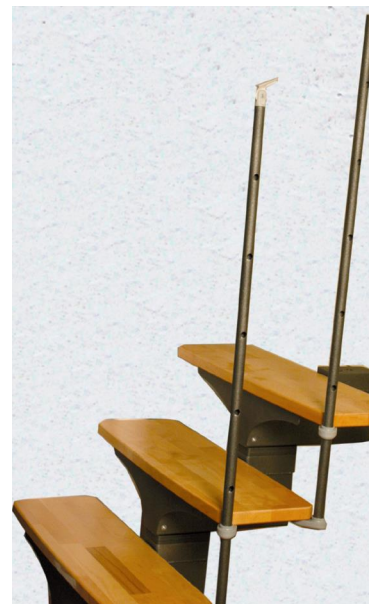

48



49



50

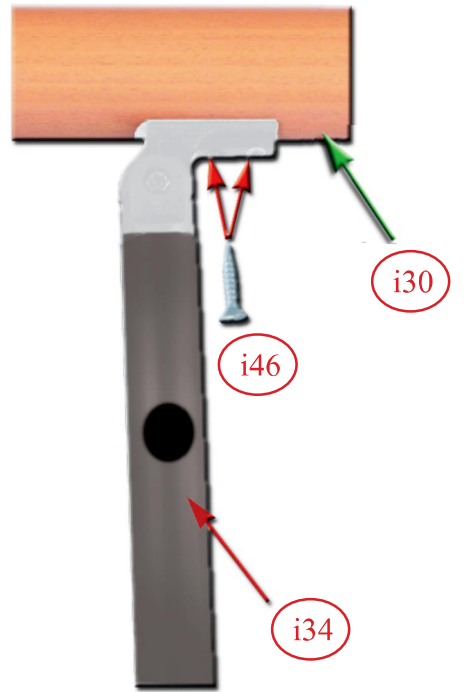

51

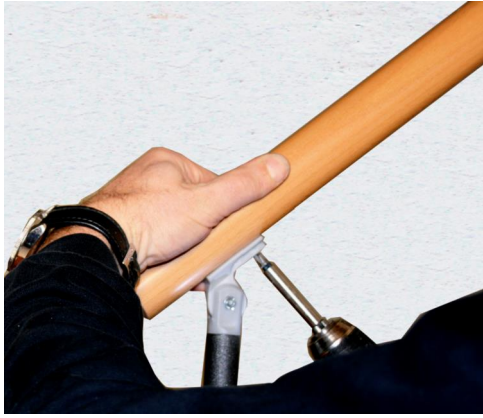

52

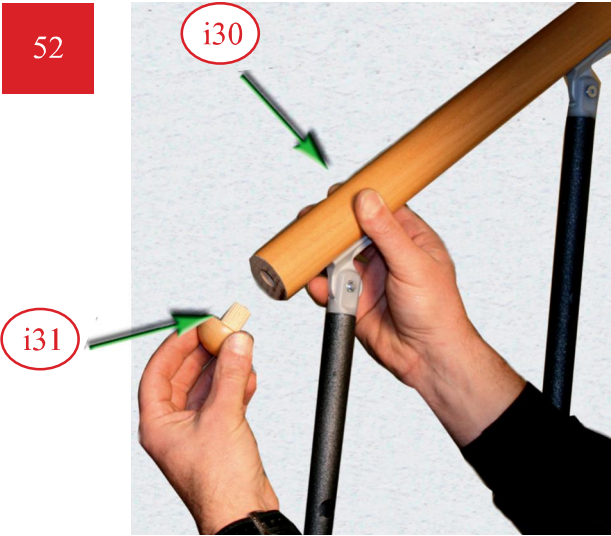

53



54

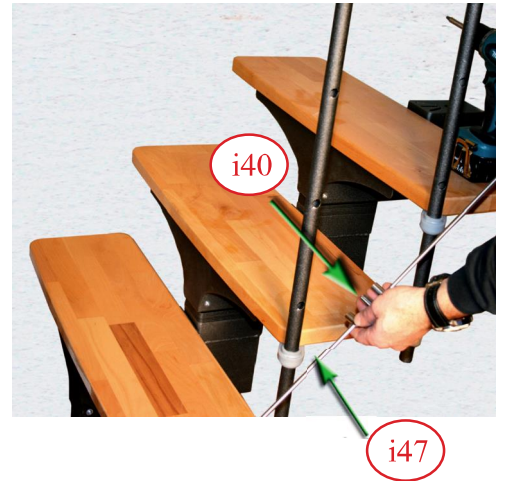

55

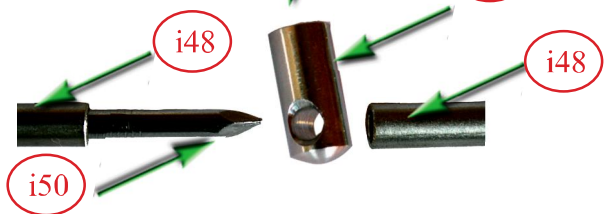
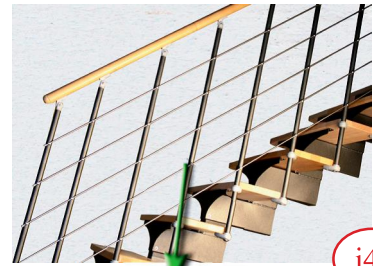

56

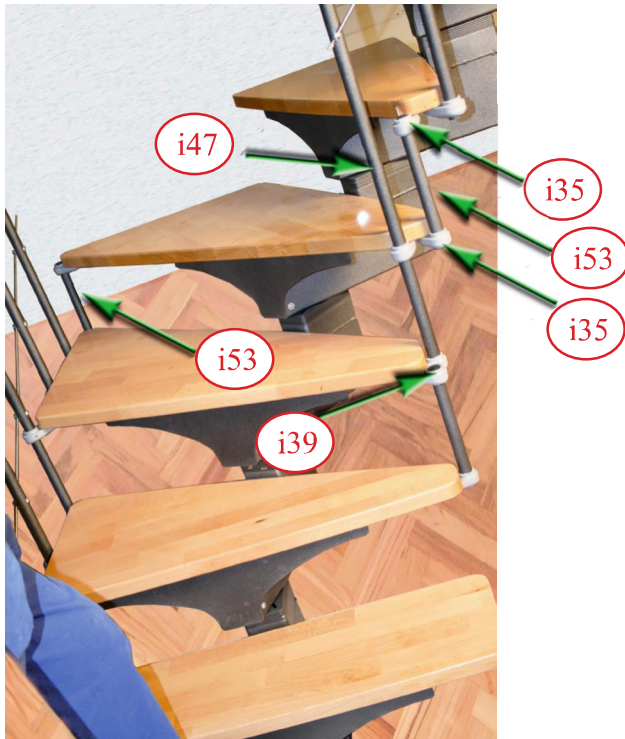
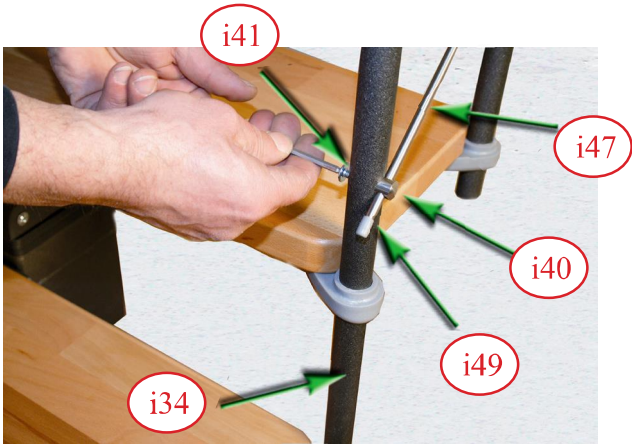
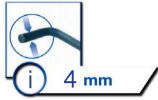

57

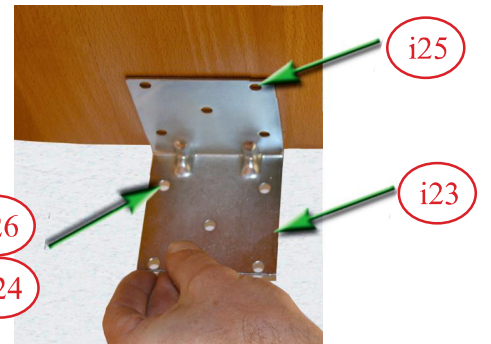



**WERK II
Kindberg / Austria
Produktion Raumspartreppen
& Spindeltreppen**

