

O (2x)

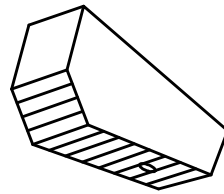

P (2x)

1

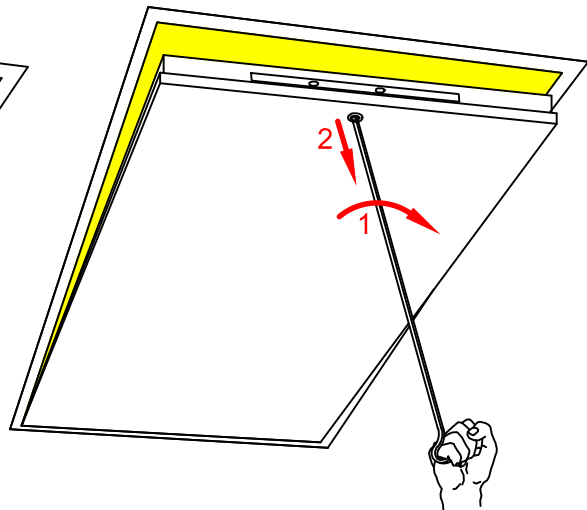
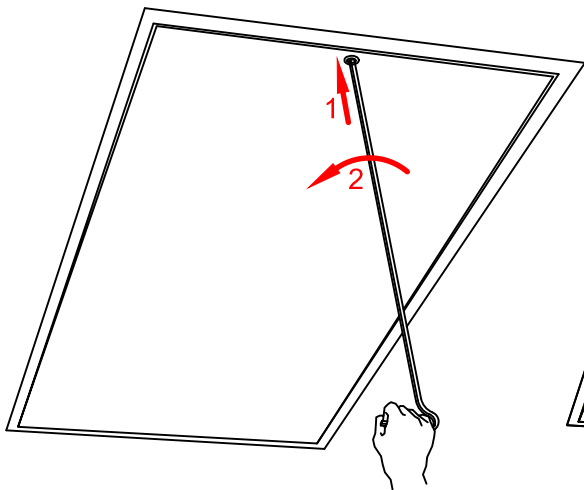



4

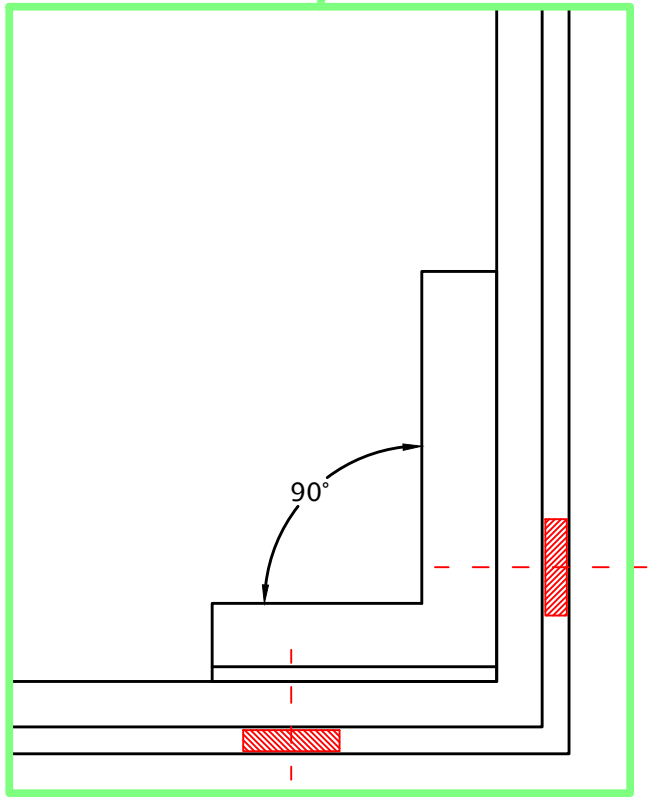
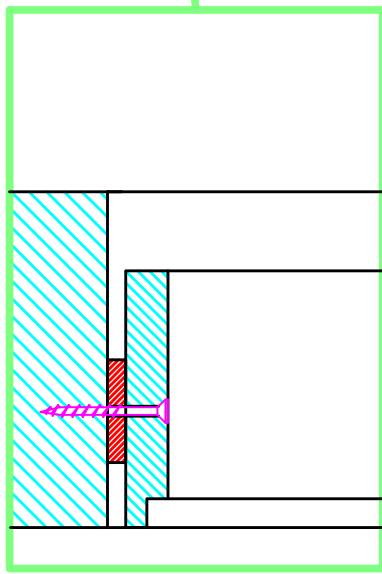
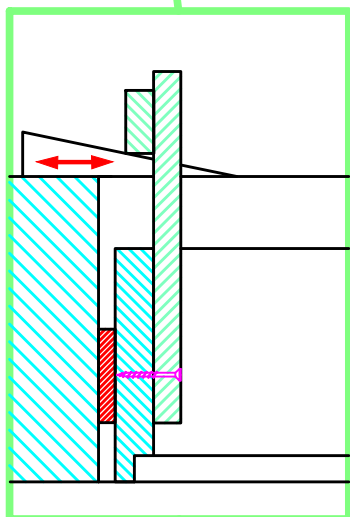
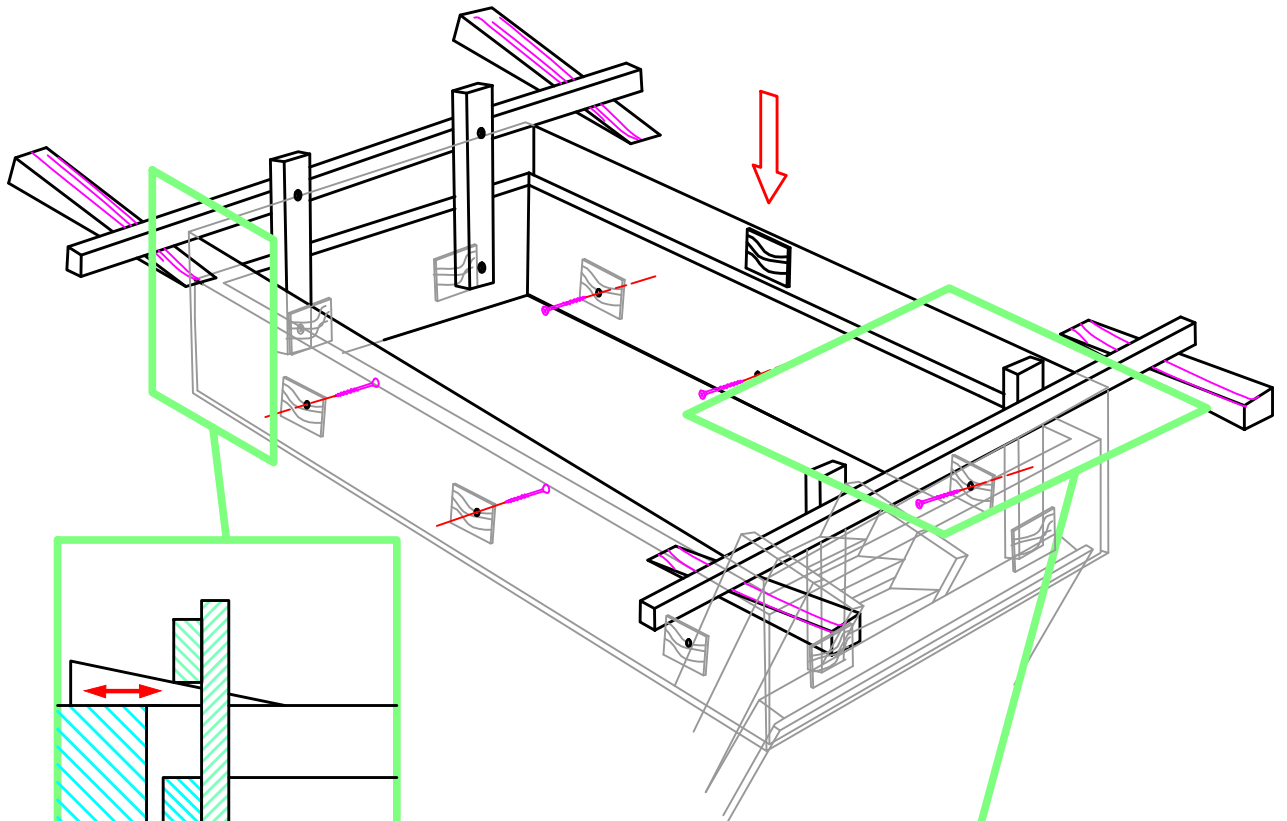

5

